

C-PHB-C-SCCT Series

Linear LED High Bay Light | Field Selectable CCT & Wattage

Replaces up to 8-Lamp - T5HO 54W

C-LITE
LED LIGHTING

A HIGH BAY WITH OPTIONS

Suit your needs with our Linear LED High Bay that delivers up to 44,700 lumens, features an 80 CRI, and is cULus Listed for damp locations. This fixture is CCT & Wattage Selectable so you can decide what you need on site. Two V-Hooks are included; chains, PIR sensor, and 6-foot cord. Plus, it's backed by our standard 5-year warranty.



PRODUCT SPECIFICATIONS

OVERVIEW

- Initial Delivered Lumens: Up to 26,100 Lumens (**S24L**), Up to 44,700 Lumens (**S42L**)
- CRI: ≥80
- CCT: Field Selectable (4000K/4500K/5000K)
- Max. Input Power: 175W (**S24L**), 290W (**S42L**)
- Dimmable: 0-10v dimming with dimming leads available for use in the field
- Operating Temperature Range: -40°F to 104°F (-40°C to 40°C)
- Replaces: 6-Lamp - T5HO 54W (**S24L**), 8-Lamp - T5HO 54W (**S42L**)
- Estimated L₇₀ Lifetime @ 25°C: >100,000 hours
- Power Factor: ≥0.9 at full load
- Total Harmonic Distortion: <20% at full load
- Limited Warranty: 5-Year*

FEATURES	RECOMMENDED USE	INPUT VOLTAGE
<ul style="list-style-type: none"> • 4000K, 4500K or 5000K color temperature options • Dual-wattage selectable • Factory installed cord, PIR motion sensor options available 	<ul style="list-style-type: none"> • Warehouse • Industrial • Retail • Gymnasium 	<ul style="list-style-type: none"> • UL: Universal Voltage (120 through 277V Operation) • UH: High Voltage (277 through 480V Operation)

ORDERING INFORMATION

Example SKU: C-PHB-C-L2F-S42L-SCCT-UL-WH-PIR-C6

C-PHB	C	L2F		SCCT		WH		
PRODUCT	SERIES	TYPE	LUMEN PACKAGE*	FIELD SELECTABLE CCT	VOLTAGE	HOUSING COLOR	PIR	CORD OPTION
C-PHB	C	L2F Linear, 2-foot length	S24L Up to 26,100 Lumens (125 & 175W) S42L Up to 44,700 Lumens (205 & 290W)	SCCT Neutral White (4000K) White (4500K)* Cool White (5000K)	UL Universal Voltage (120-277V Operation) UH High Voltage (277-480V Operation) - Not available with factory installed options.	WH White	[BLANK] No Sensor PIR PIR Motion Sensor - Requires C6 option when ordered with UH voltage	[BLANK] No Cord C6 6-foot cord

*Default settings at time of shipping are highest product wattage and 4500K. Lumen output at full power at 4500K.

CA RESIDENTS WARNING: Cancer and Reproductive Harm – www.p65warnings.ca.gov

© 2025 Cree Lighting USA LLC. All rights reserved. For informational purposes only. Content is subject to change. Patent www.creelighting.com/patents. C-Lite and the C-Lite logo are registered trademarks of Cree Lighting. Due to continuous product improvement, information in this document is subject to change. The cULus logo is a registered trademark of UL LLC. The DLC QPL, DLC QPL Premium and the DLC LUNA Logos are the registered and unregistered trademarks of Efficiency Forward, Inc.

CERTIFICATIONS:



C-PHB-C-SCCT Series

S24L

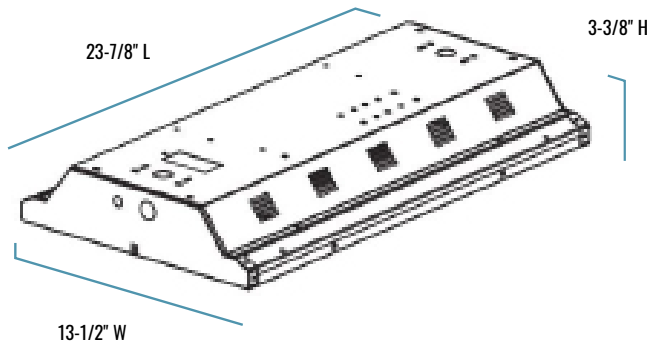

S42L

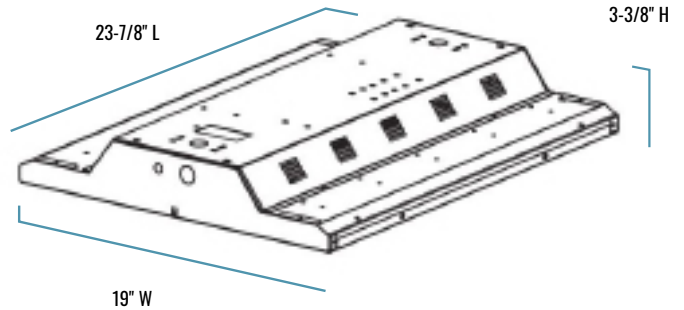

SERIES OVERVIEW

DIMENSIONS	PRODUCT WEIGHT	MOUNTING HEIGHT	SPACING
23-7/8" L x 13-1/2" W x 3-3/8" H (C-PHB-C-L2F-S24L-SCCT-UL-WH Series)	8.1 lbs.	15-25 feet	1 to 1-1/2 times the mounting height
23-7/8" L x 13-1/2" W x 3-3/8" H (C-PHB-C-L2F-S24L-SCCT-UH-WH Series)	9.4 lbs.		
23-7/8" L x 19" W x 3-3/8" H (C-PHB-C-L2F-S42L-SCCT-UL-WH Series)	11.7 lbs.	25+ feet	
23-7/8" L x 19" W x 3-3/8" H (C-PHB-C-L2F-S42L-SCCT-UH-WH Series)	13.4 lbs.		

NOTE: For C6 option, add 1 lb., for PIR option, add 2 lbs.

FIXTURE SPECIFICATIONS

HOUSING	Steel construction, with white polyester powder-coat finish.
LENS ASSEMBLY	Integrated frosted polycarbonate diffuser lens.
MOUNTING	V-Hooks (2) included, chains sold separately. Pendant/conduit mount supplied by others.
ELECTRICAL	Factory installed cords are 6ft 18AWG 600V S00W 5-wire cord.

© 2025 Cree Lighting USA LLC. All rights reserved. For informational purposes only. Content is subject to change. Patent www.creelighting.com/patents. C-Lite and the C-Lite logo are registered trademarks of Cree Lighting. Due to continuous product improvement, information in this document is subject to change. The cULus logo is a registered trademark of UL LLC. The DLC QPL, DLC QPL Premium and the DLC LUNA Logos are the registered and unregistered trademarks of Efficiency Forward, Inc.

Rev. Date: 07/07/2025

For informational purposes only. Content is subject to change. *See lighting.cree.com/warranty for details

C-LITE
LED LIGHTING

C-PHB-C-SCCT Series

LUMINAIRE AND ELECTRICAL PERFORMANCE





OPERATING TEMPERATURE RANGE	ESTIMATED L ₇₀ LIFETIME @ 25°C (77°F)	POWER FACTOR	TOTAL HARMONIC DISTORTION	SURGE PROTECTION
-40°F to 104°F (-40°C to 40°C)	>100,000 Hours	≥0.9 at full load	<20% at full load	6kV

LUMEN PACKAGE	INITIAL DELIVERED LUMENS			SYSTEM WATTS	CURRENT DRAW (AMPS)					
	4000K	4500K	5000K		120V	208V	240V	277V	347V	480V
S24L	24,200	26,100	24,400	175W	1.46	0.84	0.73	0.63	0.50	0.36
	19,000	20,500	19,200	125W	1.04	0.60	0.52	0.45	.036	0.26
S42L	42,000	44,700	42,900	290W	2.42	1.39	1.21	1.05	0.84	0.60
	32,600	34,600	33,200	205W	1.71	0.99	0.85	0.74	0.59	0.43

WARRANTY AND CERTIFICATIONS

WARRANTY	cULus LISTED	DLC
5-Year Limited*	Damp Locations	5.1 Premium Refer to https://www.designlights.org/search/ for most current information.

ACCESSORIES For use with C-PHB-C-L2F Series only

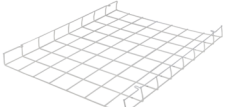
	LINEAR HIGH BAY PIR SENSOR 120-277V SKU: C-ACC-B-PIR-UL USE: With C-PHB-C series only
	LINEAR HIGH BAY PIR SENSOR 120-480V SKU: C-ACC-B-PIR USE: With C-PHB-C & C-HB-B-L2F series only
	LINEAR HIGH BAY MICROWAVE SENSOR SKU: C-ACC-B-MW USE: With C-PHB-C series only 120-277V Operation
	LINEAR HIGH BAY WIRE GUARD SKU: C-PHB-C-WG1 USE: With C-PHB-C-L2F-S24L series only
	LINEAR HIGH BAY WIRE GUARD SKU: C-PHB-C-WG2 USE: With C-PHB-C-L2F-S42L series only











© 2025 Cree Lighting USA LLC. All rights reserved. For informational purposes only. Content is subject to change. Patent www.creelighting.com/patents. C-Lite and the C-Lite logo are registered trademarks of Cree Lighting. Due to continuous product improvement, information in this document is subject to change. The cULus logo is a registered trademark of UL LLC. The DLC QPL, DLC QPL Premium and the DLC LUNA Logos are the registered and unregistered trademarks of Efficiency Forward, Inc.

Rev. Date: 07/07/2025 For informational purposes only. Content is subject to change. *See lighting.cree.com/warranty for details

C-LITE
LED LIGHTING

C-PHB-C-SCCT Series

ACCESSORIES For use with C-PHB-C-L2F Series only

	3-FOOT CHAIN SUSPENSION KIT STEEL*
	SKU: C-ACC-A-CHAIN-3FT
	6-FOOT CHAIN SUSPENSION KIT STEEL*
	SKU: C-ACC-A-CHAIN-6FT
	12-FOOT CHAIN SUSPENSION KIT STEEL*
	SKU: C-ACC-A-CHAIN-12FT
	6-FOOT CORD & 120V 3-BLADE TWIST-LOCK PLUG
	SKU: C-ACC-A-CRDS-6FT-LV-TL
	6-FOOT CORD & 120V STRAIGHT BLADE PLUG
	SKU: C-ACC-A-CRDS-6FT-LV-SB
	6-FOOT CORD & 277V 3-BLADE TWIST LOCK PLUG
	SKU: C-ACC-A-CRDS-6FT-HV-TL
	6-FOOT CORD & 208/240V 3-BLADE TWIST LOCK PLUG
	SKU: C-ACC-A-CRDS-6FT-MV-TL
	120V 3-WIRE TWIST-LOCK RECEPTACLE
	SKU: C-ACC-A-RECEP-LV-TL
	277V 3-WIRE TWIST-LOCK RECEPTACLE
	SKU: C-ACC-A-RECEP-HV-TL
	208/240V 3-WIRE TWIST-LOCK RECEPTACLE
	SKU: C-ACC-A-RECEP-MV-TL

*Kit includes 2 steel chains. One kit needed per fixture.

© 2025 Cree Lighting USA LLC. All rights reserved. For informational purposes only. Content is subject to change. Patent www.creelighting.com/patents. C-Lite and the C-Lite logo are registered trademarks of Cree Lighting. Due to continuous product improvement, information in this document is subject to change. The eULus logo is a registered trademark of UL LLC. The DLC QPL, DLC QPL Premium and the DLC LUNA Logos are the registered and unregistered trademarks of Efficiency Forward, Inc.

US: creelighting.com, e-conolight.com **Distribution/Sales:** 855-617-2733 **Customer Service:** 888-243-9445

Rev. Date: 07/07/2025 For informational purposes only. Content is subject to change. *See lighting.cree.com/warranty for details

C-LITE
LED LIGHTING