

# C-FL-A-SPRT Series

LED Sports Light | w/ Multiple Beam Spread Options

Replaces two 1000W MH



## BECOME THE REAL MVP WITH THIS HIGH QUALITY LED SPORTS LIGHT

Our C-FL-A-SPRT Series C-Lite LED Sports Light is one you can rely on and is offered with many options to suit your application needs. Choose from 120-277V or 347-480V operation, with multiple beam spreads. Delivering up to 100,200 lumens with a cULus Listing, this LED Sports Light has surpassed quality testing so you're the real MVP with this product. Backed by our 5-year limited warranty.



- Rotatable single bolt mount with angle adjustment or double bolt mount to accommodate most T-Bar's
- 0-10V dimmable
- 20°, 30°, 40° or 50° beam spreads available

## PRODUCT SPECIFICATIONS

### OVERVIEW

- Delivered Lumens: 100,200
- CRI:  $\geq 70$
- CCT: 5000K
- Input Power: 664W
- Dimmable: Yes
- Power Factor:  $\geq 0.9$  at full load
- Total Harmonic Distortion:  $< 25\%$  at full load
- Limited Warranty: 5-year
- Replaces: Two 1000W MH
- EPA Rating: 2.12

FEATURES	RECOMMENDED USE	INPUT VOLTAGE
<ul style="list-style-type: none"> <li>• 20-50 degree beam optical distribution</li> <li>• High strength die-cast aluminum housing</li> <li>• Multiple mounting options</li> </ul>	<ul style="list-style-type: none"> <li>• Flag Poles</li> <li>• Sporting Applications</li> <li>• Yard and Dock</li> </ul>	<ul style="list-style-type: none"> <li>• Universal (120V - 277V)</li> <li>• High voltage (347-480V)</li> </ul>

### ORDERING INFORMATION

Example SKU: C-FL-A-SPRT-20D-100L-50K-UL-BZ-10KV

C-FL-A	SPRT			100L	50K		BZ	10KV
PRODUCT	STYLE	BEAM OPTICAL DISTRIBUTION		LUMEN PACKAGE	CCT	VOLTAGE	COLOR	SURGE PROTECTION
C-FL-A	SPRT Sport Light	<b>20D</b> 20 Degree Beam	<b>40D</b> 40 Degree Beam	<b>100L</b> 100,200 Lumens (664W)	<b>50K</b> 5000K (Cool White)	<b>UL</b> Universal (120-277V) <b>UH</b> High Voltage (347-480V)	<b>BZ</b> Bronze	<b>10KV</b> 10kV surge protection

### CERTIFICATIONS:

CA RESIDENTS WARNING: Cancer and Reproductive Harm – [www.p65warnings.ca.gov](http://www.p65warnings.ca.gov)



# C-FL-A-SPRT Series

## LUMINAIRE AND ELECTRICAL PERFORMANCE

OPERATING TEMPERATURE RANGE	ESTIMATED L <sub>70</sub> LIFETIME @ 25°C (77°F)	POWER FACTOR	TOTAL HARMONIC DISTORTION
-40°F to 104°F (-40°C to 40°C)	> 100,000 hours	≥0.9 at full load	< 25% at full load

SKU	LUMEN PACKAGE	SYSTEM WATTS	CURRENT DRAW (AMPS)					
			120V	208V	240V	277V	347V	480V
C-FL-A-SPRT-20D-100L-50K-UL-BZ-10KV	100,200	664	5.4A	3.1A	2.7A	2.4A	n/a	n/a
C-FL-A-SPRT-30D-100L-50K-UL-BZ-10KV			5.4A	3.1A	2.7A	2.4A	n/a	n/a
C-FL-A-SPRT-40D-100L-50K-UL-BZ-10KV			5.4A	3.1A	2.7A	2.4A	n/a	n/a
C-FL-A-SPRT-50D-100L-50K-UL-BZ-10KV			5.4A	3.1A	2.7A	2.4A	n/a	n/a
C-FL-A-SPRT-20D-100L-50K-UH-BZ-10KV			n/a	n/a	n/a	n/a	1.92A	1.39A
C-FL-A-SPRT-30D-100L-50K-UH-BZ-10KV			n/a	n/a	n/a	n/a	1.92A	1.39A
C-FL-A-SPRT-40D-100L-50K-UH-BZ-10KV			n/a	n/a	n/a	n/a	1.92A	1.39A
C-FL-A-SPRT-50D-100L-50K-UH-BZ-10KV			n/a	n/a	n/a	n/a	1.92A	1.39A

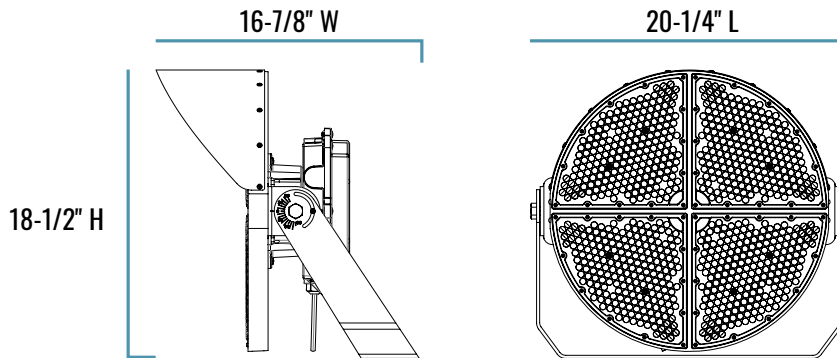

## SERIES OVERVIEW

PRODUCT DIMENSIONS	PRODUCT WEIGHT	MOUNTING HEIGHT
20-1/4" L x 16-7/8" W x 18-1/2" H	33.07 lbs.	> 25 feet

## FIXTURE SPECIFICATIONS

<b>HOUSING</b>	Bronze, high strength die-cast aluminum housing
<b>LENS ASSEMBLY</b>	Integrated polycarbonate uv-stabilized lens
<b>MOUNTING</b>	Rotatable single bolt mount with angle adjustment or double bolt mount to accommodate most T-Bar's

# C-FL-A-SPRT Series

## C-FL-A-SPRT-20D

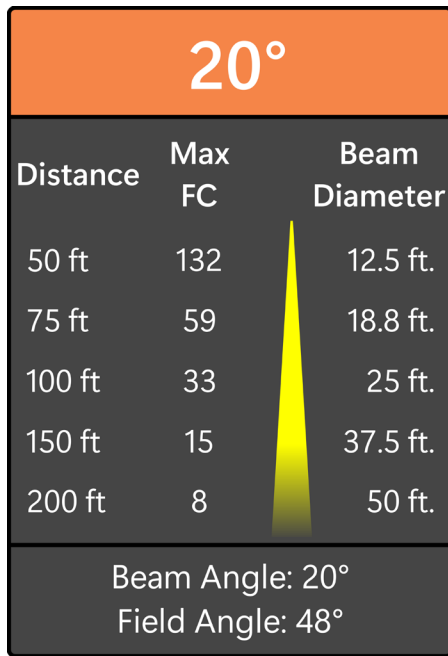

## C-FL-A-SPRT-30D

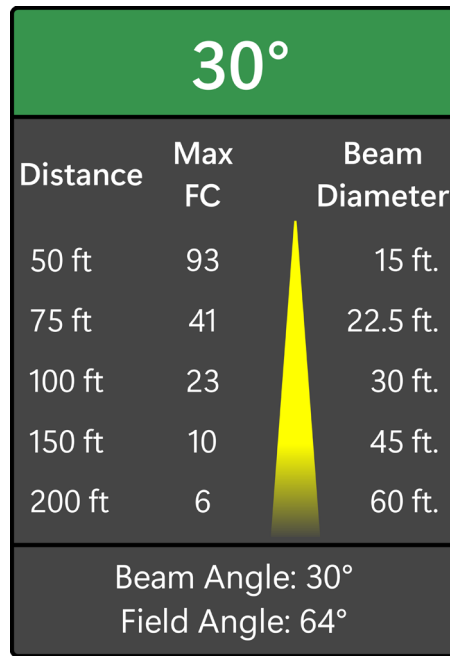

## C-FL-A-SPRT-40D

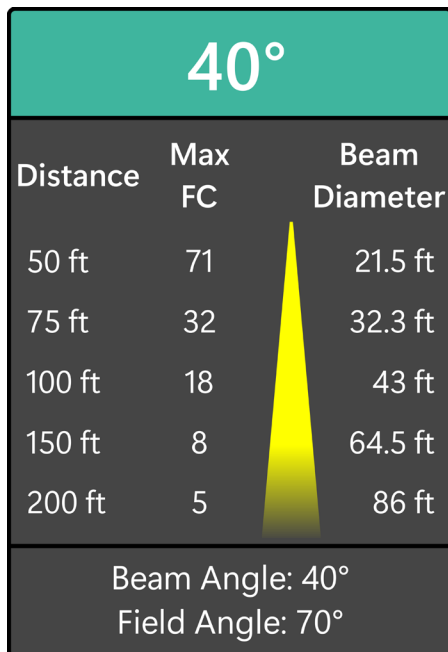

## C-FL-A-SPRT-50D

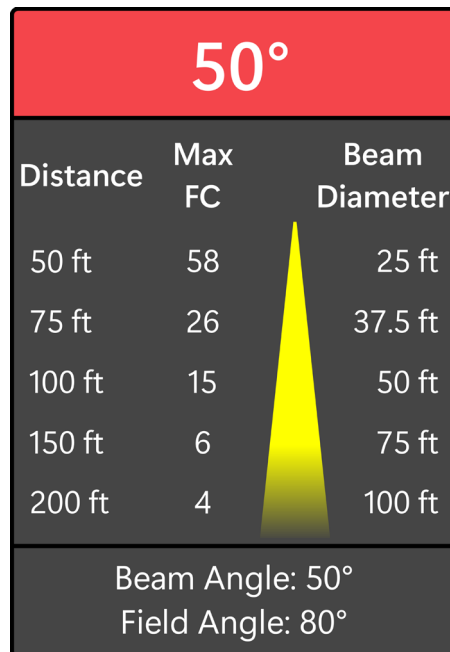

# C-FL-A-SPRT Series

## ISO PLOT CHART

### C-FL-A-SPRT-20D

Mounting Height: 100'

Fixture Tilt: 45°

Note: This is using the "20D" 20° beam optic distribution.

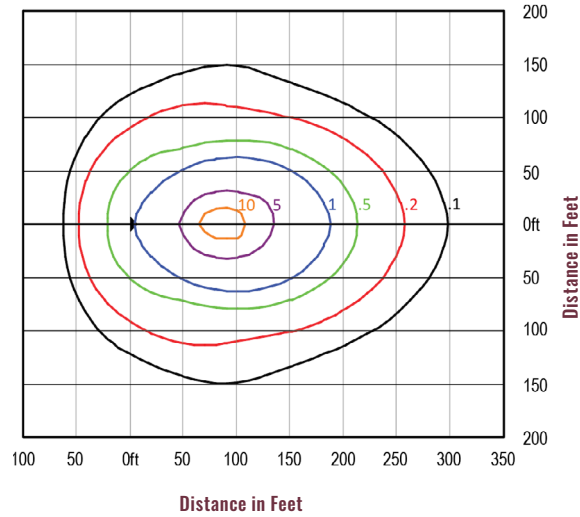

### C-FL-A-SPRT-30D

Mounting Height: 100'

Fixture Tilt: 45°

Note: This is using the "30D" 30° beam optic distribution.

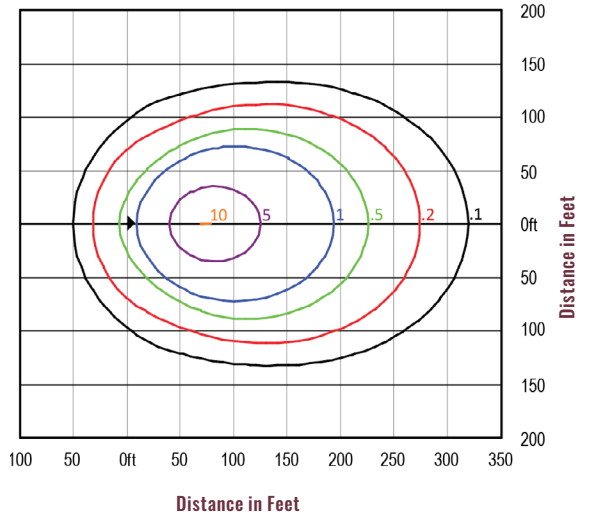

### C-FL-A-SPRT-40D

Mounting Height: 100'

Fixture Tilt: 45°

Note: This is using the "40D" 40° beam optic distribution.

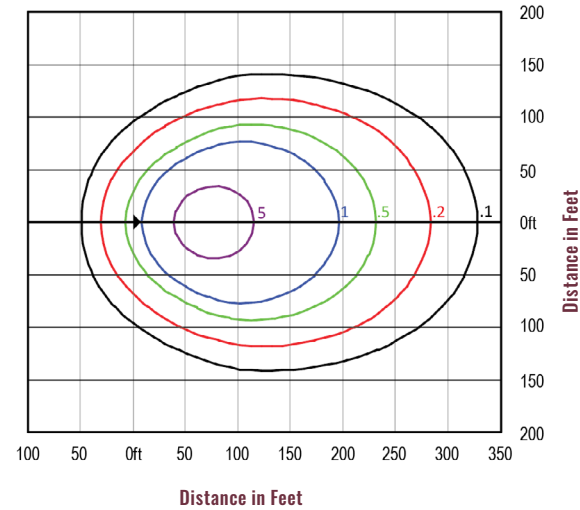

### C-FL-A-SPRT-50D

Mounting Height: 100'

Fixture Tilt: 45°

Note: This is using the "50D" 50° beam optic distribution.

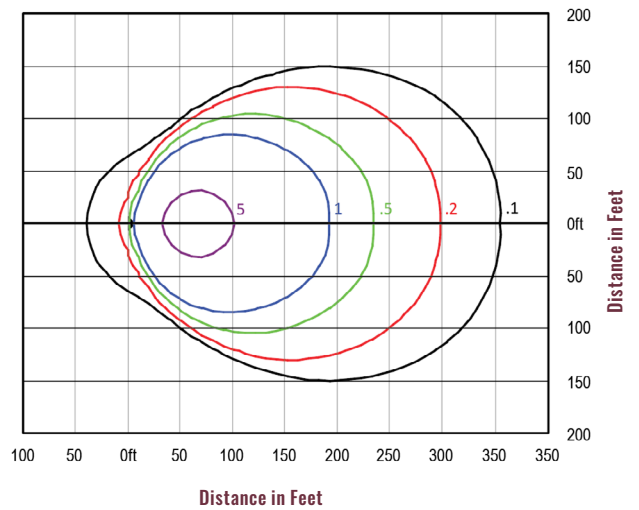

**Note:** All published photometric testing performed to IES LM-79-08 standards. Fixture photometry was completed on a single representative fixture. Foot candle levels are noted inside graph.

## WARRANTY AND CERTIFICATIONS

WARRANTY	cULus LISTED	DLC
5-Year Limited	Wet Locations	—

©2024 Cree Lighting USA LLC. All rights reserved. For informational purposes only. Content is subject to change. Patent [www.creelighting.com/patents](http://www.creelighting.com/patents). C-Lite and the C-Lite logo are registered trademarks of Cree Lighting. The cULus logo is a registered trademark of UL LLC.

Rev. Date: V1 05/02/2024

For informational purposes only. Content is subject to change. \*See <https://www.e-conolight.com/warranties>

**C-LITE**  
LED LIGHTING